

HELICAL GEARS - 45° HELIX ANGLE

**48 NORMAL PITCH
.187 FACE
.2498 BORE**

20° PRESSURE ANGLE, AGMA Quality 10

RIGHT OR LEFT HAND

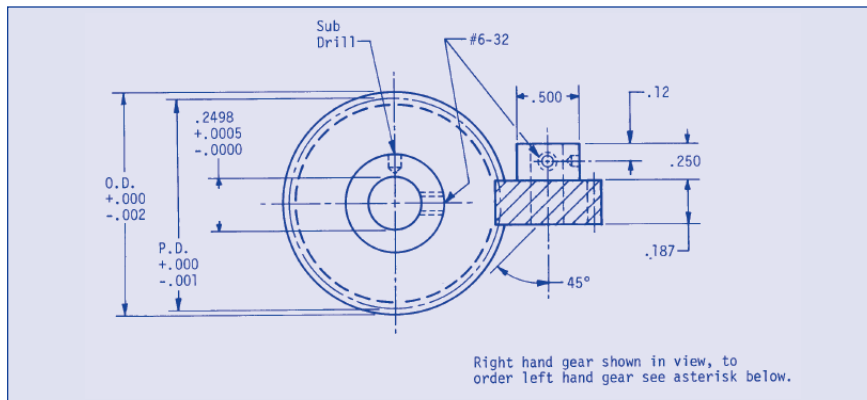

Material: 303 Stainless Steel
2024-T4 Aluminum – Anodized before gear cutting.

ORDER BY CATALOG NUMBER

303 STAINLESS STEEL	2024 T4-ALUMINUM Anodized before cutting	GEAR DATA		
Right Hand * Catalog Number	Right Hand * Catalog Number	Number of Teeth	Pitch Diameter	Outside Diameter
LKS-E3-20	LKA-E3-20	20	.5892	.631
LKS-E3-25	LKA-E3-25	25	.7365	.778
LKS-E3-30	LKA-E3-30	30	.8838	.925
LKS-E3-35	LKA-E3-35	35	1.0311	1.072
LKS-E3-40	LKA-E3-40	40	1.1784	1.220
LKS-E3-45	LKA-E3-45	45	1.3258	1.367
LKS-E3-50	LKA-E3-50	50	1.4730	1.514
LKS-E3-60	LKA-E3-60	60	1.7676	1.809
LKS-E3-70	LKA-E3-70	70	2.0622	2.104
LKS-E3-80	LKA-E3-80	80	2.3568	2.398
LKS-E3-90	LKA-E3-90	90	2.6516	2.693
LKS-E3-100	LKA-E3-100	100	2.9460	2.987

*To order left hand type gears use – E4 in place of – E3 in catalog number.

Example: LKA-E4-20 = Left Hand (Aluminum)
LKA-E3-20 = Right Hand (Aluminum)

For unlisted numbers of teeth, pitch, special blanks, material or helix angle, please inquire for price.